

Features

- Ideal for indication light on hand held products
- Long life and robust package
- Variety of lens types and color choices available
- Package : 2000 pcs / reel
- Moisture sensitivity level : level 3
- RoHS compliant



ATTENTION
OBSERVE PRECAUTIONS
FOR HANDLING
ELECTROSTATIC
DISCHARGE
SENSITIVE
DEVICES

Package Schematics

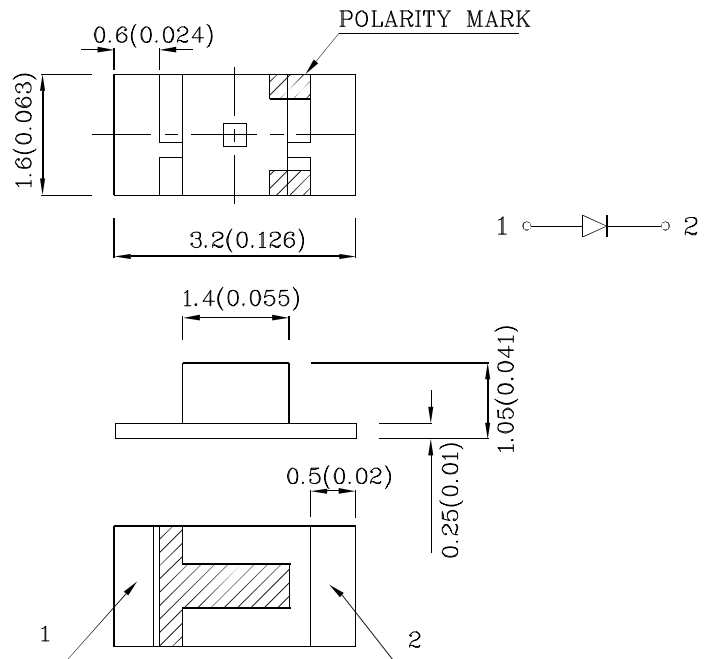

Notes:

1. All dimensions are in millimeters (inches).
2. Tolerance is $\pm 0.2(0.008)$ " unless otherwise noted.
3. Specifications are subject to change without notice.

| Absolute Maximum Ratings ($T_A=25^\circ\text{C}$) | | DG (InGaN) | Unit |
|--|-----------|---------------|------|
| Reverse Voltage | V_R | 5 | V |
| Forward Current | I_F | 25 | mA |
| Forward Current (Peak) 1/10 Duty Cycle 0.1ms Pulse Width | i_{FS} | 150 | mA |
| Power Dissipation | P_D | 102.5 | mW |
| Operating Temperature | T_A | -40 ~ +85 | °C |
| Storage Temperature | T_{stg} | -40 ~ +85 | |
| Electrostatic Discharge Threshold (HBM) | | 450 | V |

| Operating Characteristics ($T_A=25^\circ\text{C}$) | | DG (InGaN) | Unit |
|---|-----------------|---------------|---------------|
| Forward Voltage (Typ.) ($I_F=20\text{mA}$) | V_F | 3.3 | V |
| Forward Voltage (Max.) ($I_F=20\text{mA}$) | V_F | 4.1 | V |
| Reverse Current (Max.) ($V_R=5\text{V}$) | I_R | 50 | μA |
| Wavelength of Peak Emission (Typ.) ($I_F=20\text{mA}$) | λ_P | 515 | nm |
| Wavelength of Dominant Emission (Typ.) ($I_F=20\text{mA}$) | λ_D | 525 | nm |
| Spectral Line Full Width At Half-Maximum (Typ.) ($I_F=20\text{mA}$) | $\Delta\lambda$ | 30 | nm |
| Capacitance (Typ.) ($V_F=0\text{V}$, $f=1\text{MHz}$) | C | 45 | pF |

| Part Number | Emitting Color | Emitting Material | Lens-color | Luminous Intensity ($I_F=20\text{mA}$) mcd | | Wavelength nm λ_P | Viewing Angle 20 1/2 |
|-------------|----------------|-------------------|-------------|--|------|---------------------------------|-------------------------|
| | | | | min. | typ. | | |
| XZDG55W-2 | Green | InGaN | Water Clear | 280 | 447 | 515 | 120° |

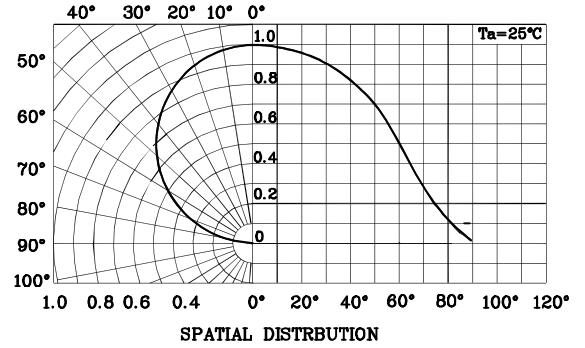
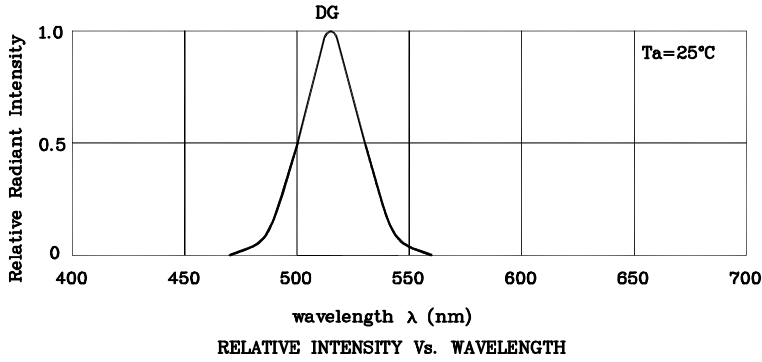

❖ DG

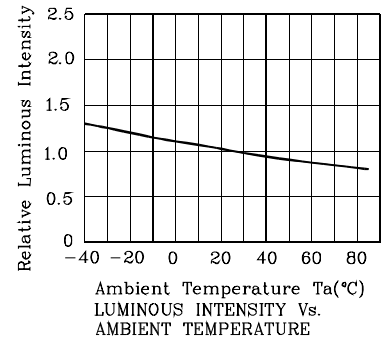
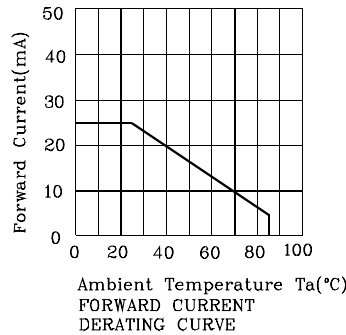
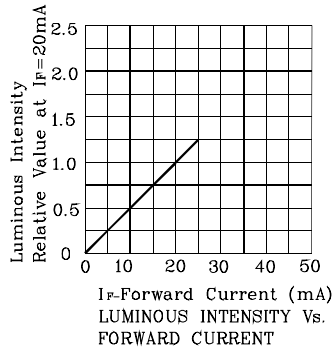
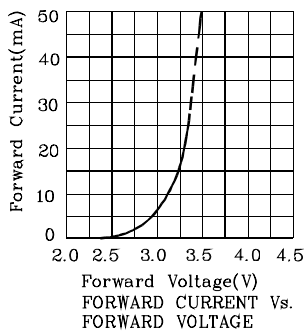

LED is recommended for reflow soldering and soldering profile is shown below.

Reflow Soldering Profile for SMD Products (Pb-Free Components)



- Notes:
1. Maximum soldering temperature should not exceed 260°C
 2. Recommended reflow temperature: 145°C-260°C
 3. Do not put stress to the epoxy resin during high temperatures conditions



❖ The device has a single mounting surface.
The device must be mounted according to the specifications.

❖ Recommended Soldering Pattern
(Units : mm; Tolerance: ± 0.1)

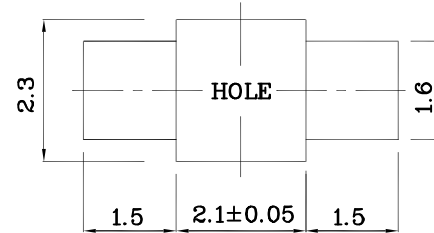
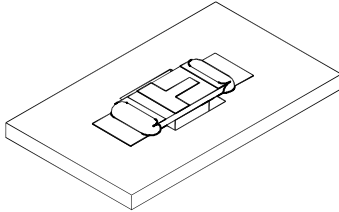

❖ Reel Dimension



❖ Tape Specification (Units : mm)

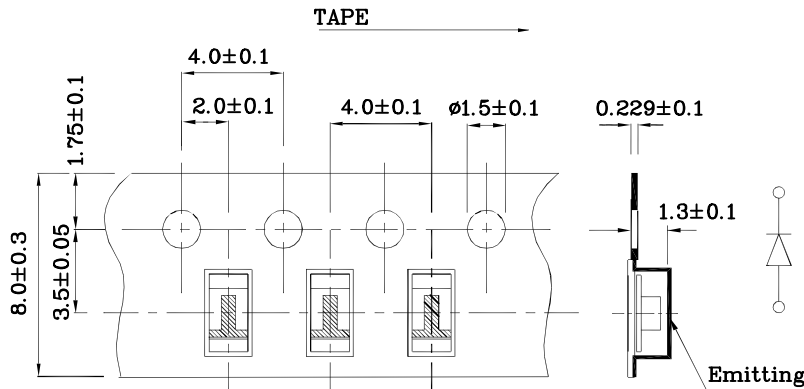



Remarks:

If special sorting is required (e.g. binning based on forward voltage, Luminous intensity / luminous flux, or wavelength), the typical accuracy of the sorting process is as follows:

1. Wavelength: $\pm 1\text{nm}$
2. Luminous intensity / luminous flux: $\pm 15\%$
3. Forward Voltage: $\pm 0.1\text{V}$

Note: Accuracy may depend on the sorting parameters.

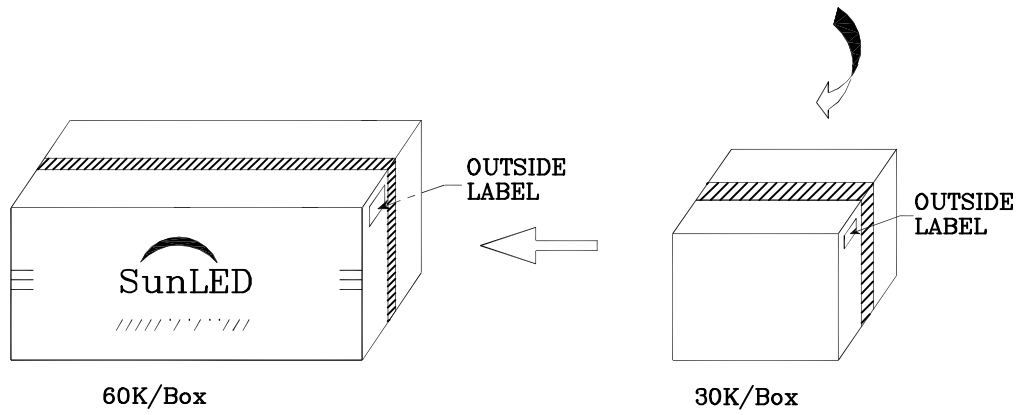
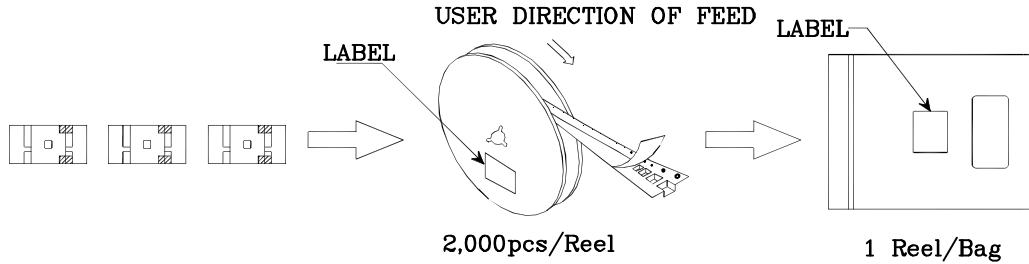
PACKING & LABEL SPECIFICATIONS

| | |
|--|-----------|
| Q.C. Q C | |
| XX XX XXXX PASSED | |
| P/NO : XZxxx55x-2 | |
| QTY : 2,000 pcs | CODE: XXX |
| S/N : XX | |
| LOT NO : | |
|  XXXXXXXXXXXXXXXXXXXXXXXXXXXX | |
| RoHS Compliant | |